

Name: G-2
Main ID Number: 086581528A
 Secondary ID Number: G-2
 DNA Number: 14394
 D.O.B.: 5/22/06
 Score: _____

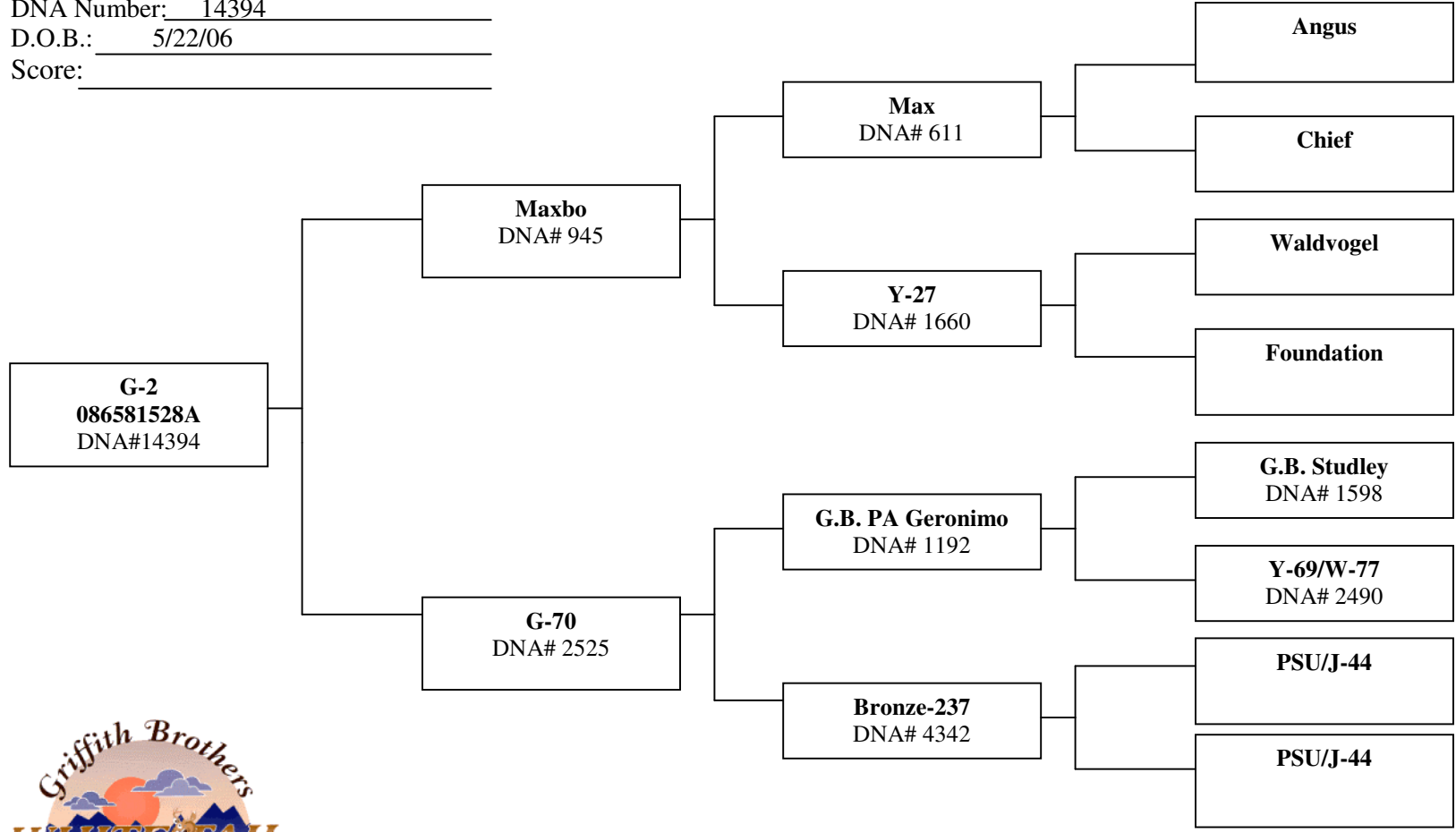

Comments: _____
